

14.0611/1

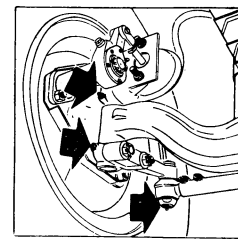

08.671/1

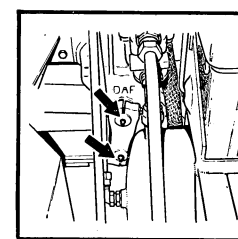

25/11

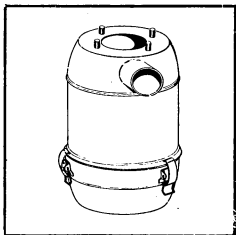

26.0216/2

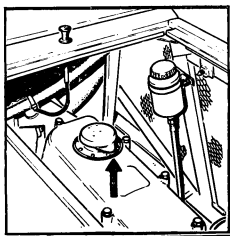

139/1-5

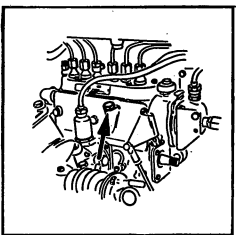

26.0442



6-69/9

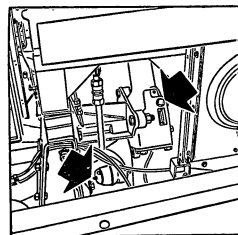
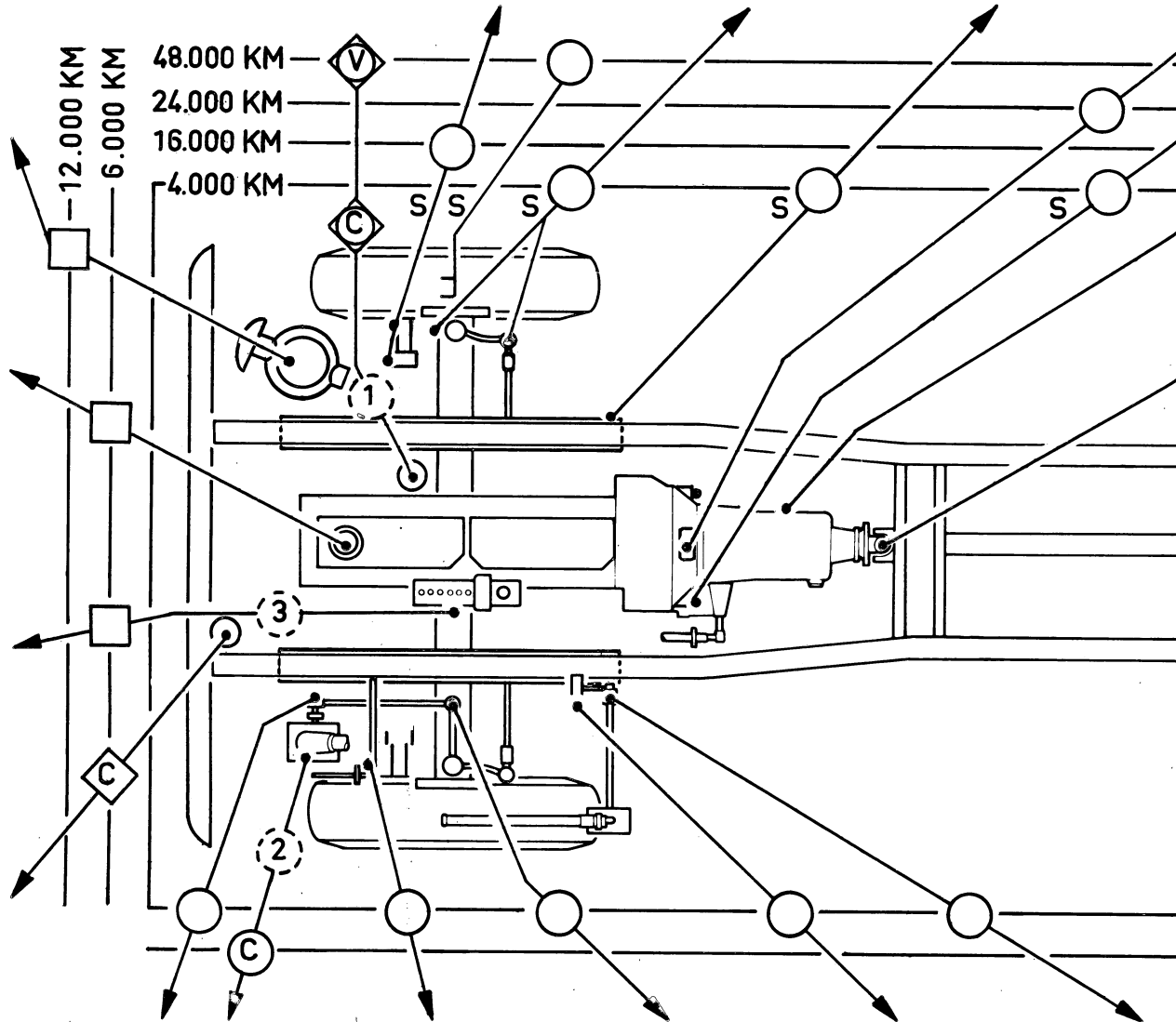

12.0189/1

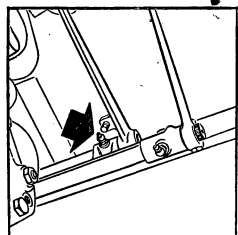

17.0162/1

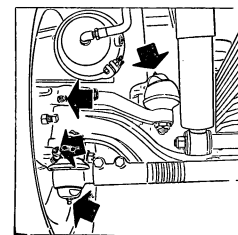

08.0672/1

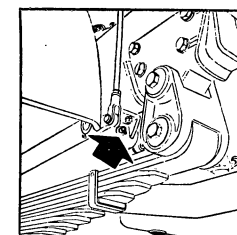

03.097/1

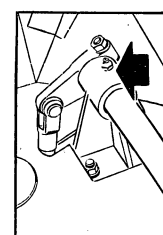

12.0

1. Indien chassis is voorzien van een hydraulische stuurbekrachtiging dient het oliepeil in het reservoir iedere 2.000 km te worden gecontroleerd.
2. Niet van toepassing, indien chassis is uitgerust met een hydraulische stuurbekrachtiging.
3. Alleen DO-motor.

# SMEERSHEMA

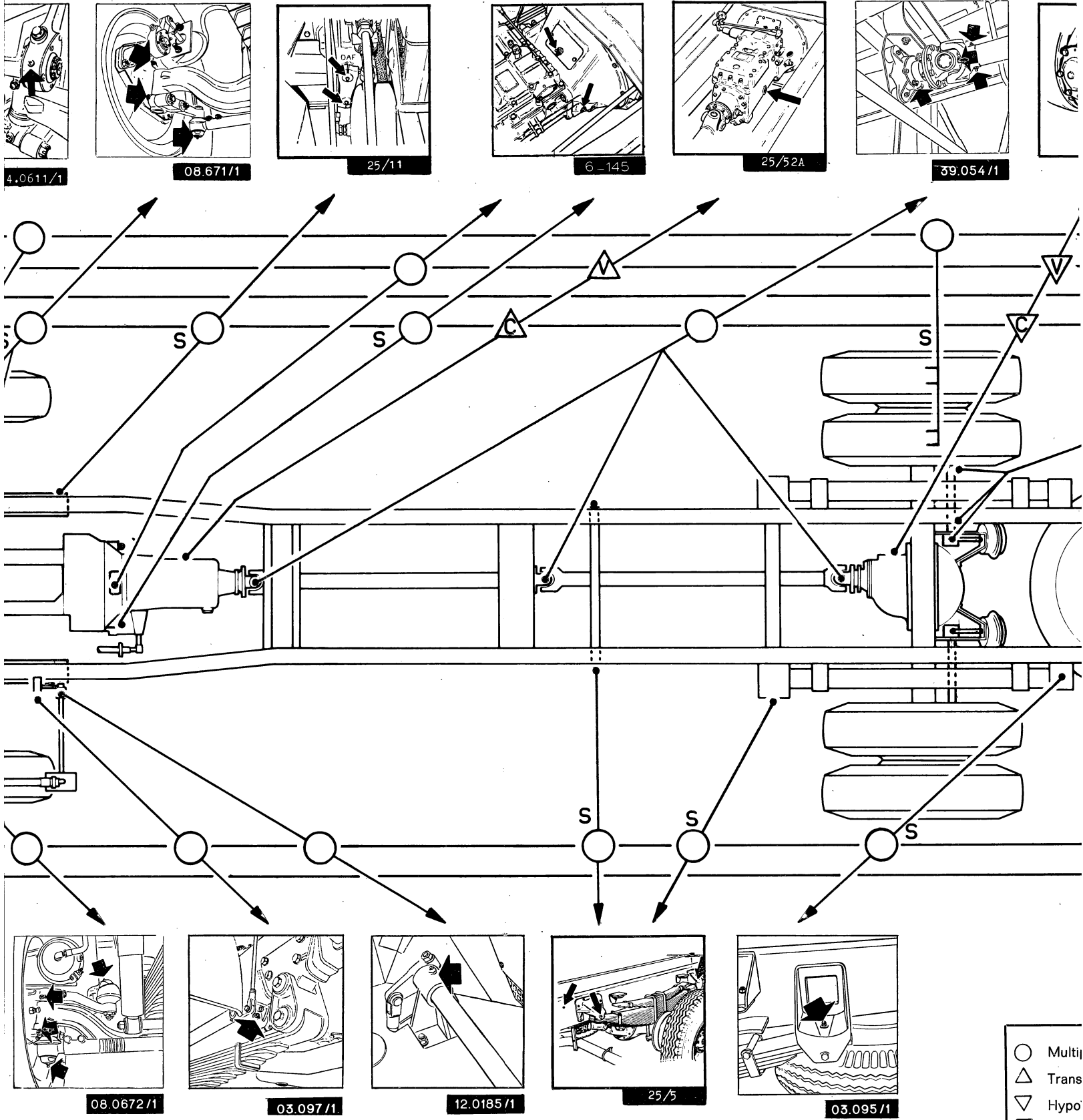

is voorzien van een hydraulische stuurbevoorrchtiging dient het reservoir iedere 2.000 km te worden gecontroleerd.

assing, indien chassis is uitgerust met een hydraulische stuur-

tor.

# SCHEMA

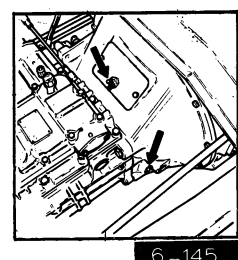

6-145

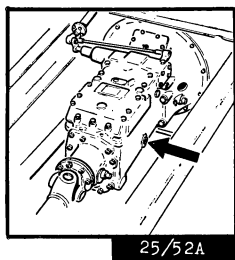

25/52A

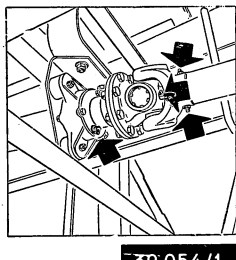

39.054/1

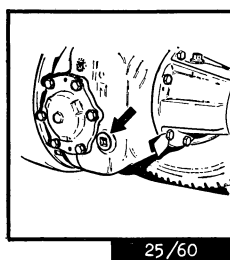

25/60

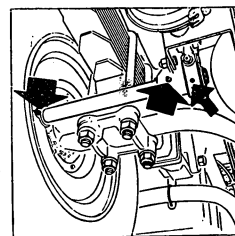
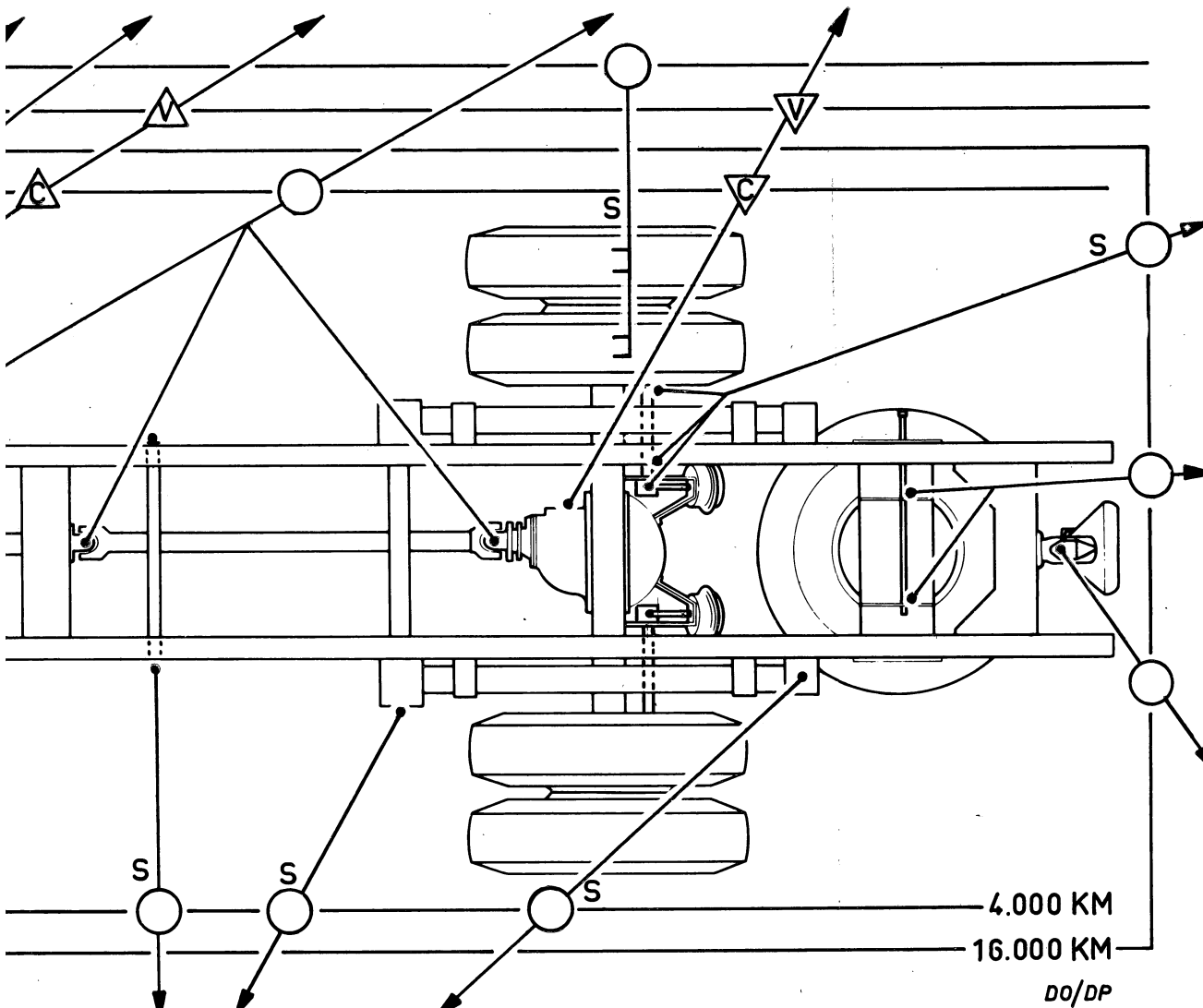

08.0670/2

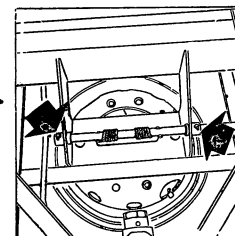

11.057/1

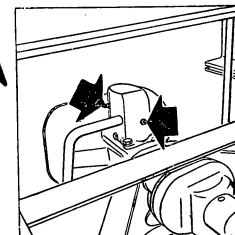

39.053/1



85/1

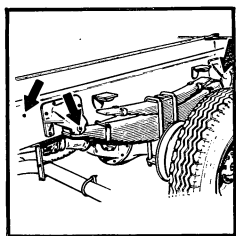

25/5

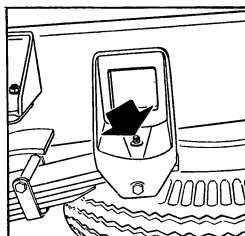

03.095/1

- |   |                           |     |             |
|---|---------------------------|-----|-------------|
| ○ | Multipurpose vet          | C = | Controleren |
| △ | Transmissie olie          | S = | Symmetrisch |
| ▽ | Hypoïd olie               | V = | Verversen   |
| □ | Motor olie                |     |             |
| ◇ | Remvloeistof              |     |             |
| ◊ | Automat. transmissie olie |     |             |