

08.0866

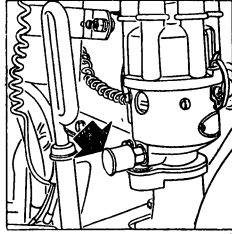

50.0428

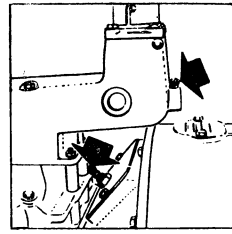

35.0165

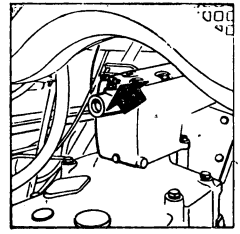

36.01064

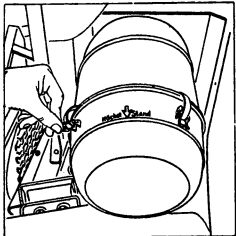

26.0306

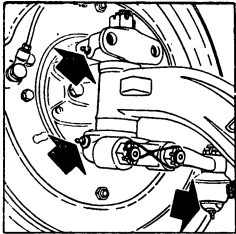

08.0901

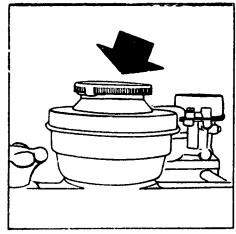

20.01859

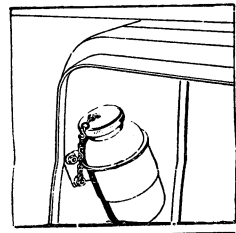

14.0595

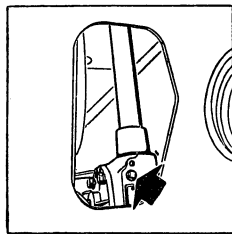
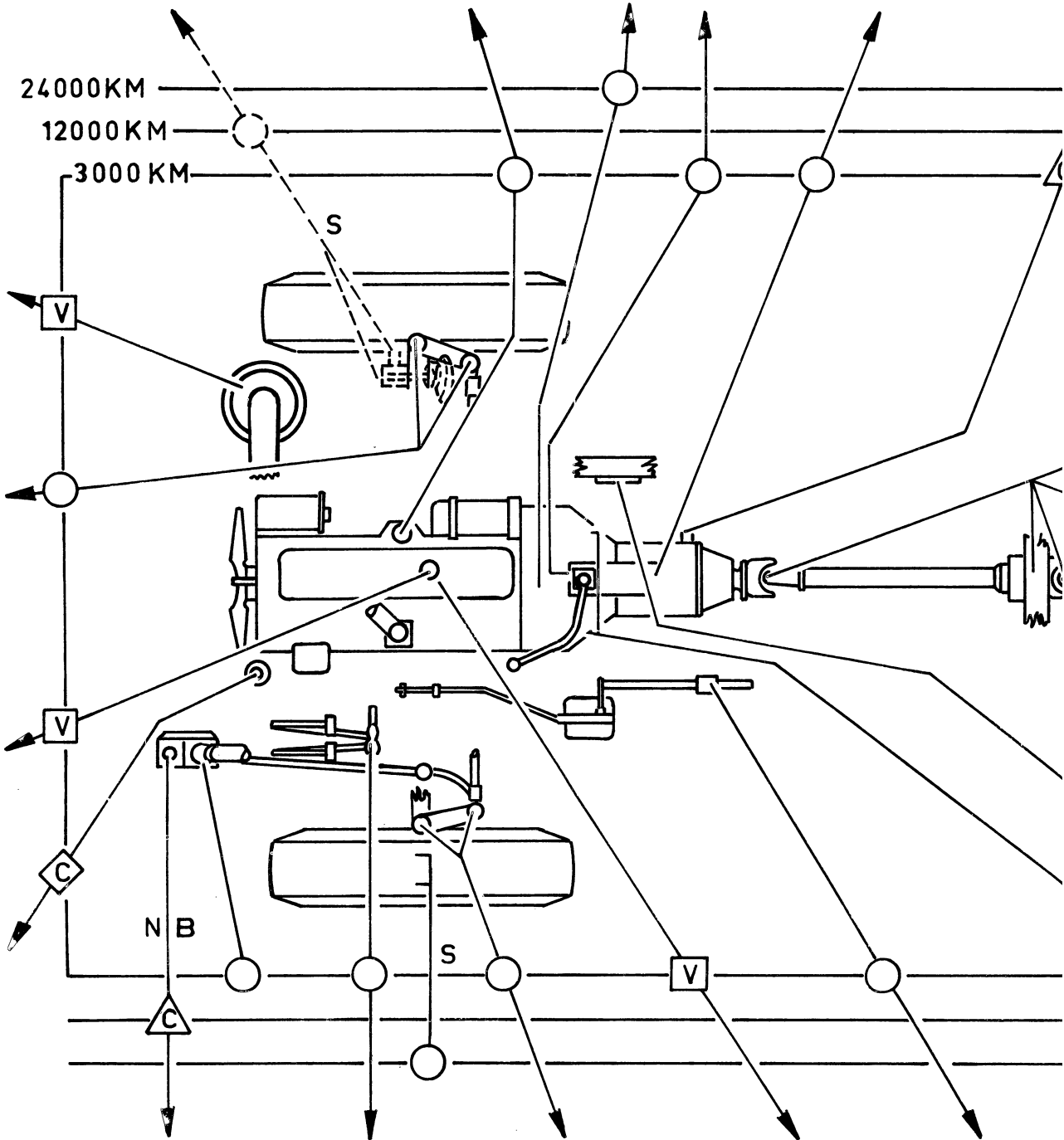

12.0286

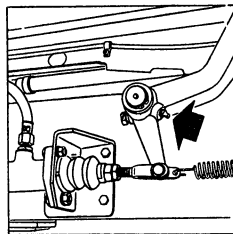

17.0273

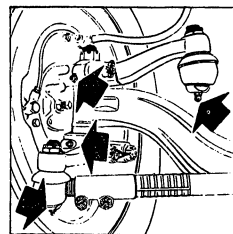

08.0900

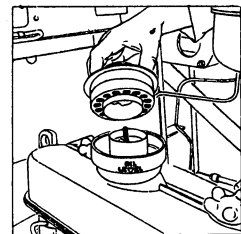

26.0302

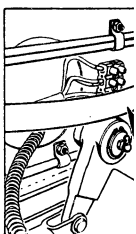

N.B.: Het hydraulische stuurmechanisme
Het mechanische stuurmechanisme

MEERSHEMA

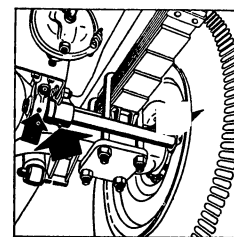
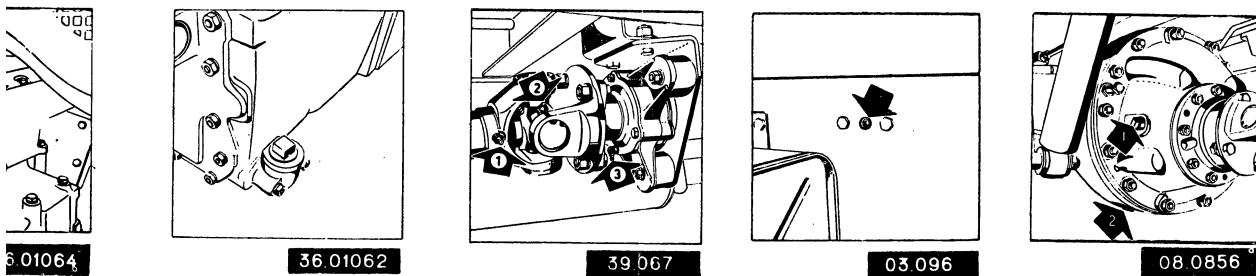

08.0872

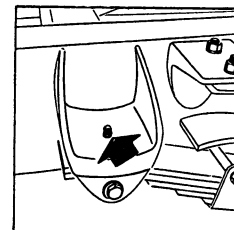

03.0132

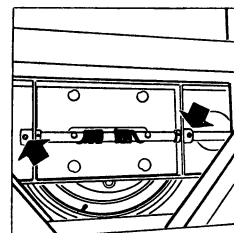

11.0116

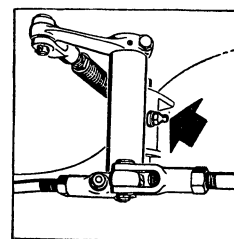

17.0237

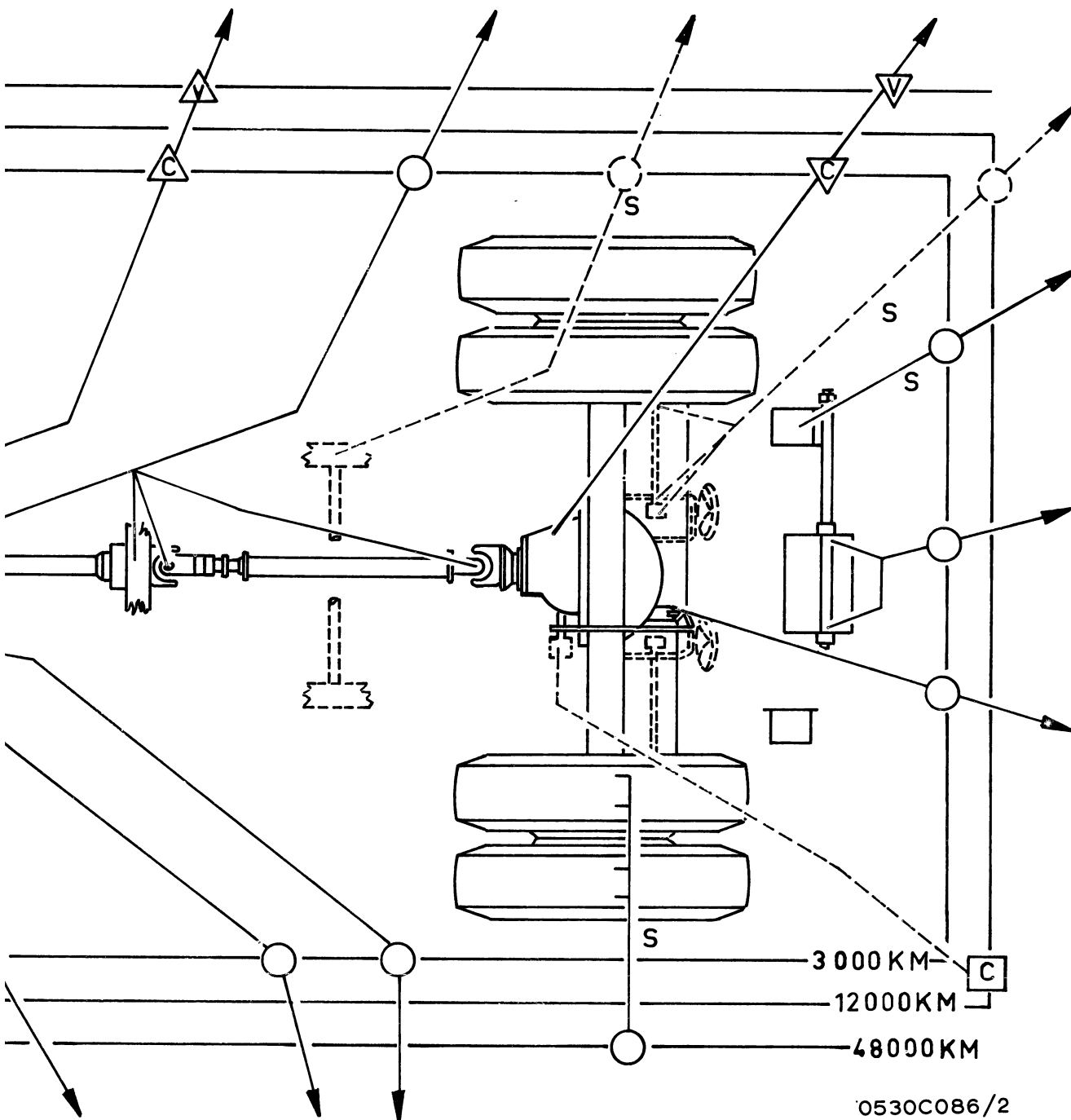

- Multipurpose vet
- △ Transmissie olie
- ▽ Hypoid olie
- Motorolie
- ◇ Remvloeistof
- V Verversen
- C Controleren
- S Symmetrisch

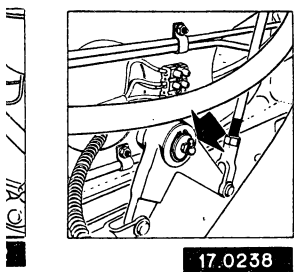

17.0238

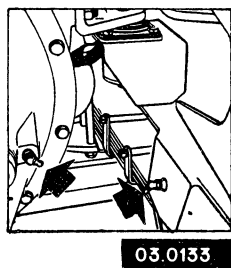

03.0133

stuurmechanisme iedere 24.000 km verversen.
 stuurmechanisme behoeft geen olierversing.