

08.0866

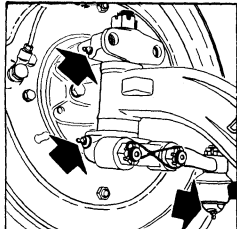

08.0901

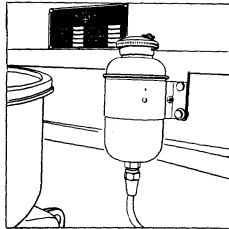

14.0600

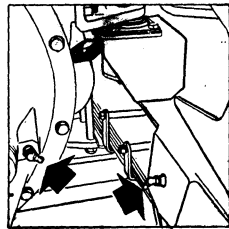

03.0133

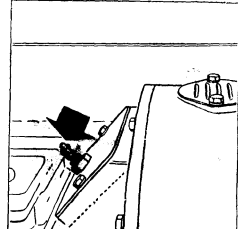

35.0165 /1

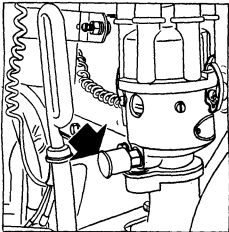

50.0428

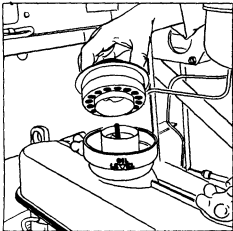

26.0302

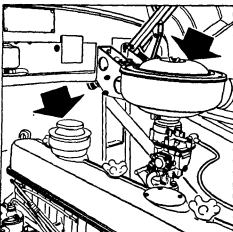

20.01833

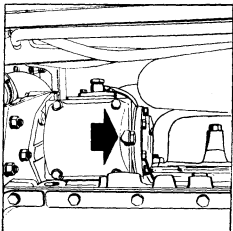

40.0139 /1

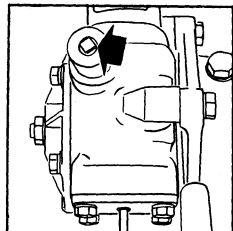
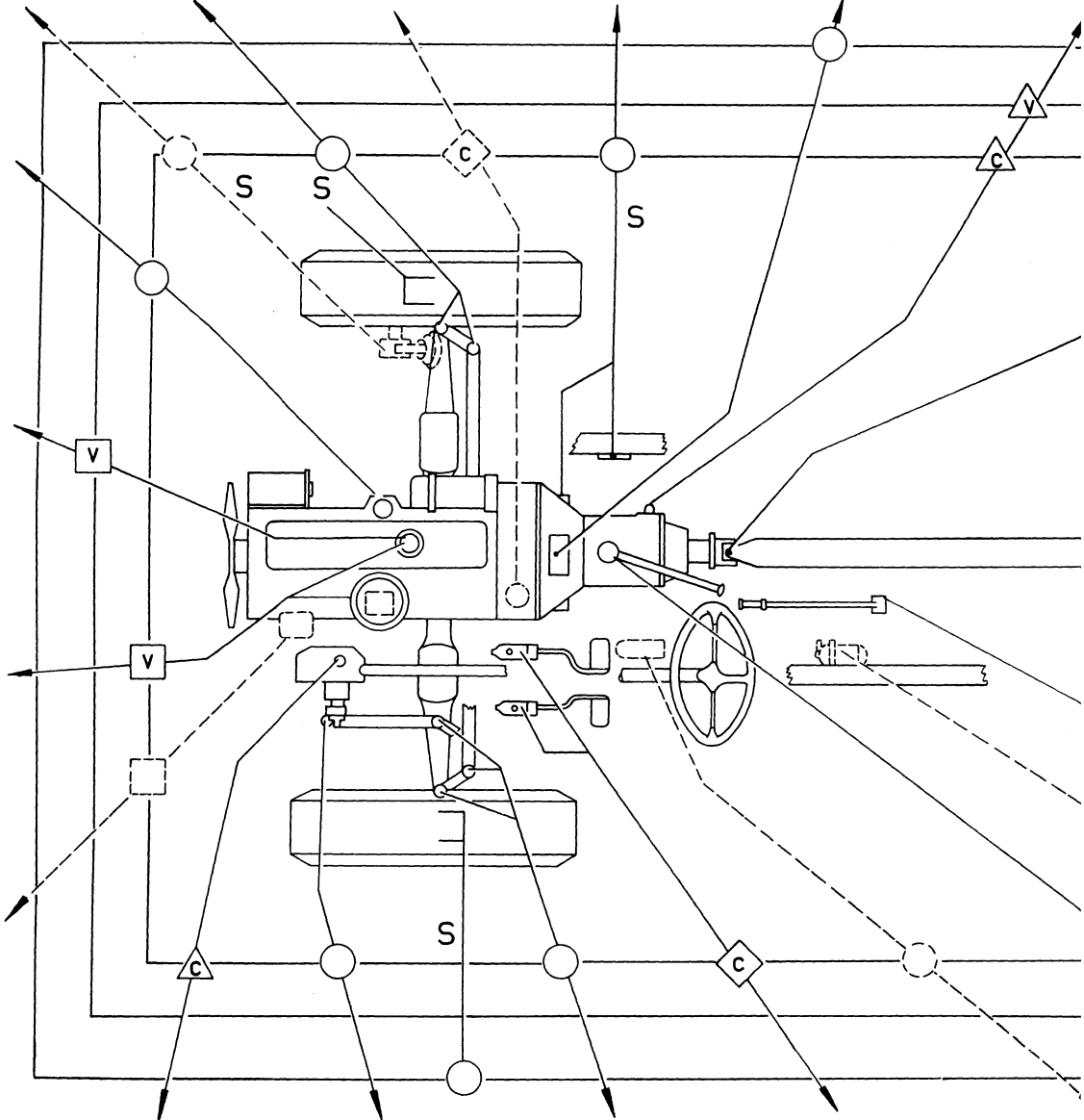

20.01251/1

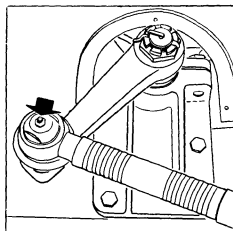

12.0175 /1

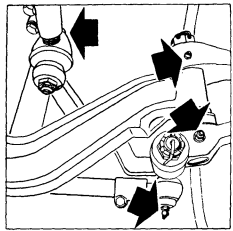

08.0984

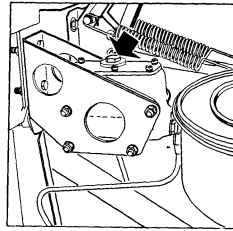

14.0392 /1

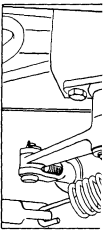

SCHEMA

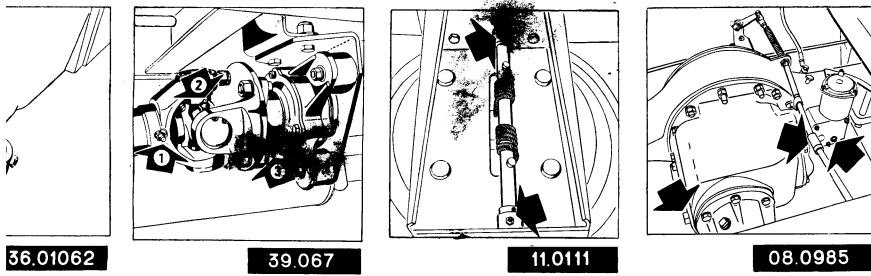

○	Multipurpose vet	◇	Remvloeistof
△	Transmissie olie	V	Verversen
▽	Hypoid olie	C	Controleren
□	Motor olie	S	Symmetrisch

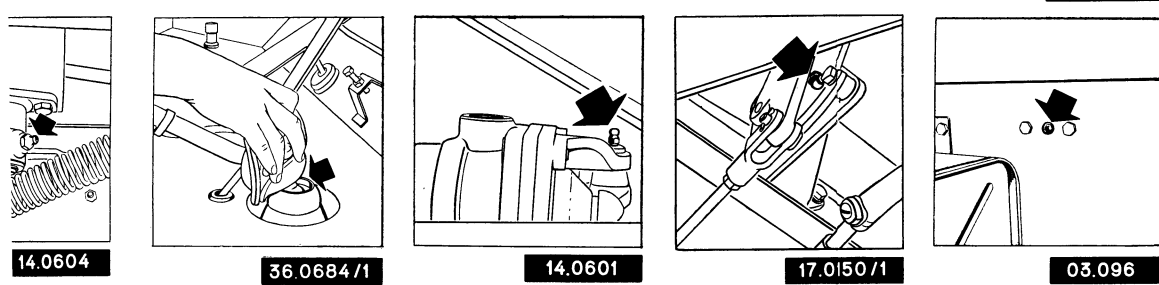
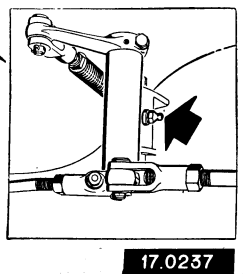
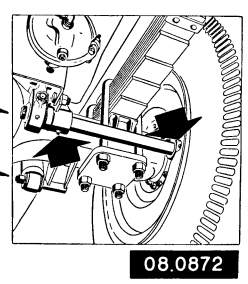
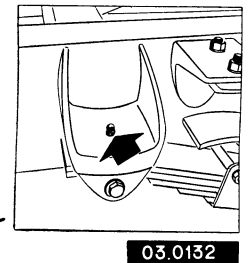
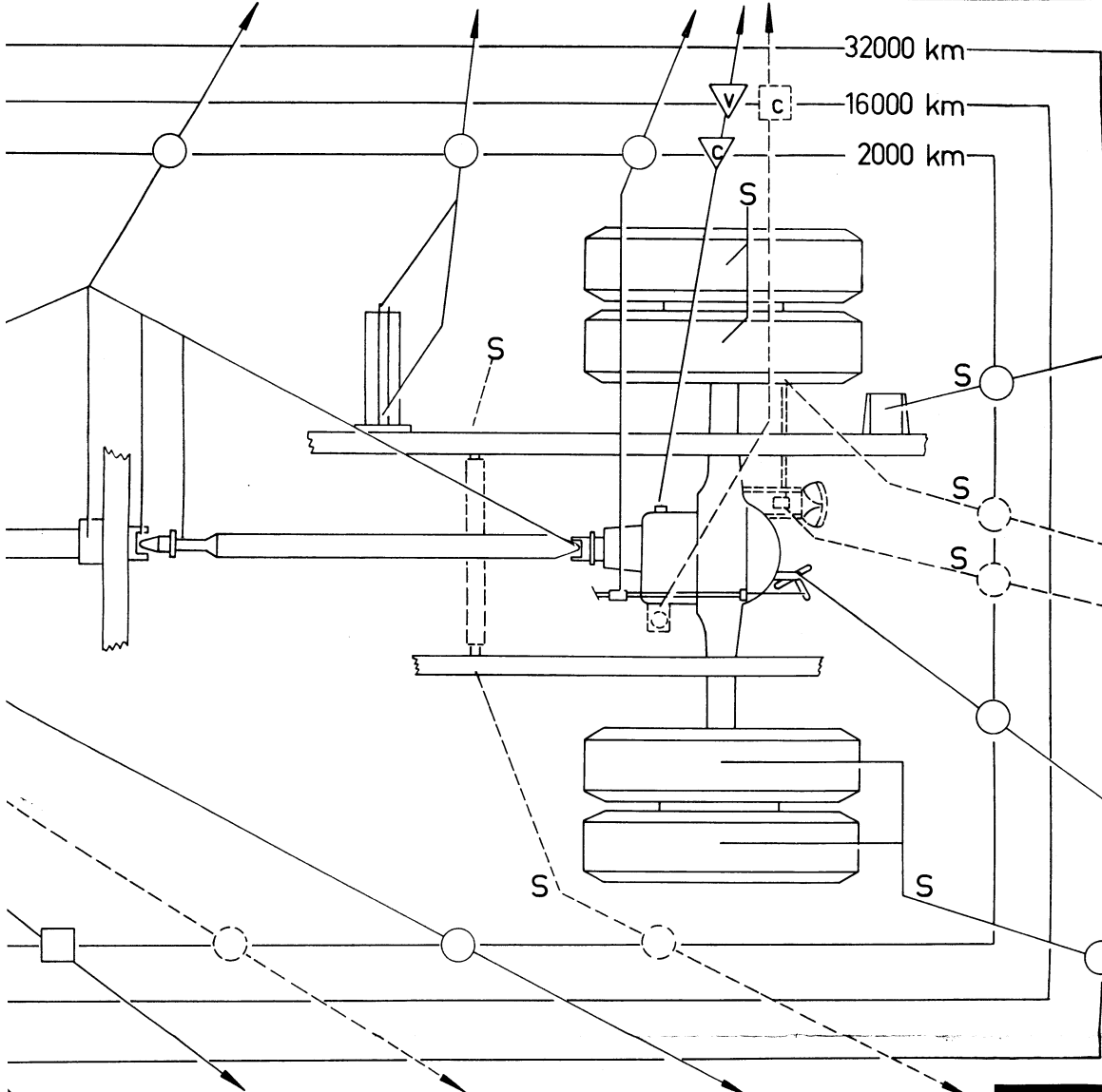

0.530C.096