

1

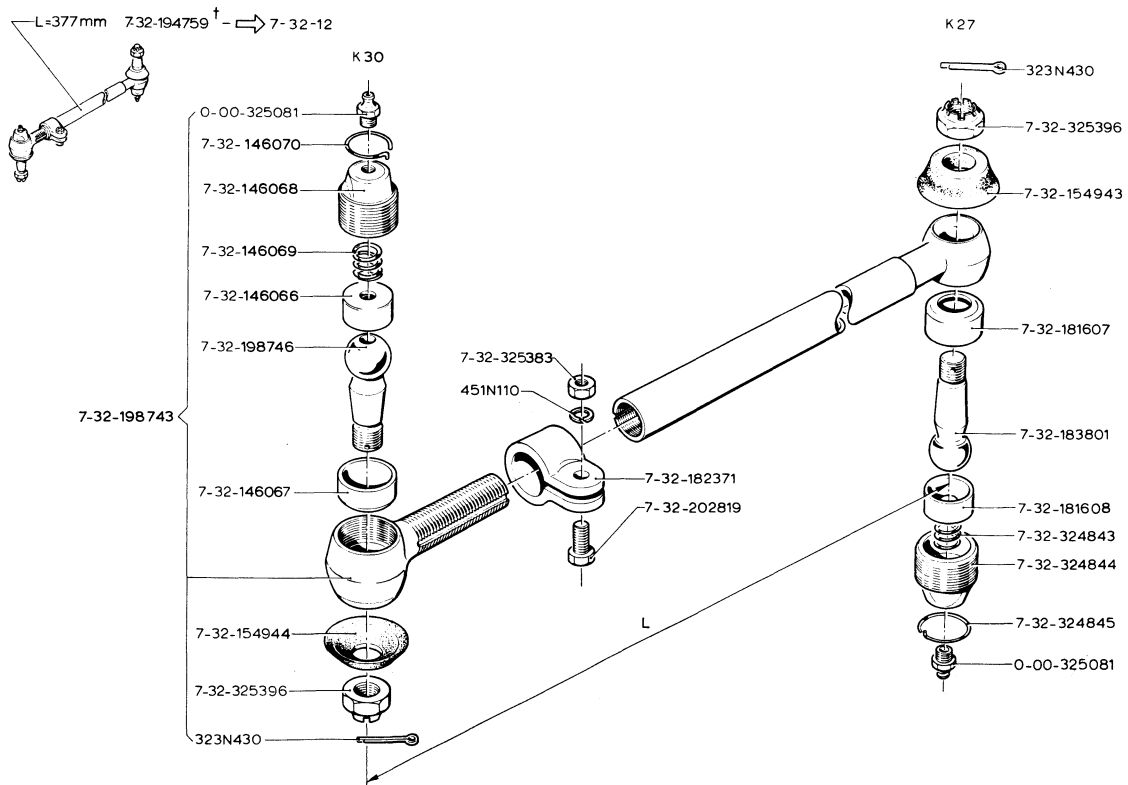

2

Printed in Holland 0266

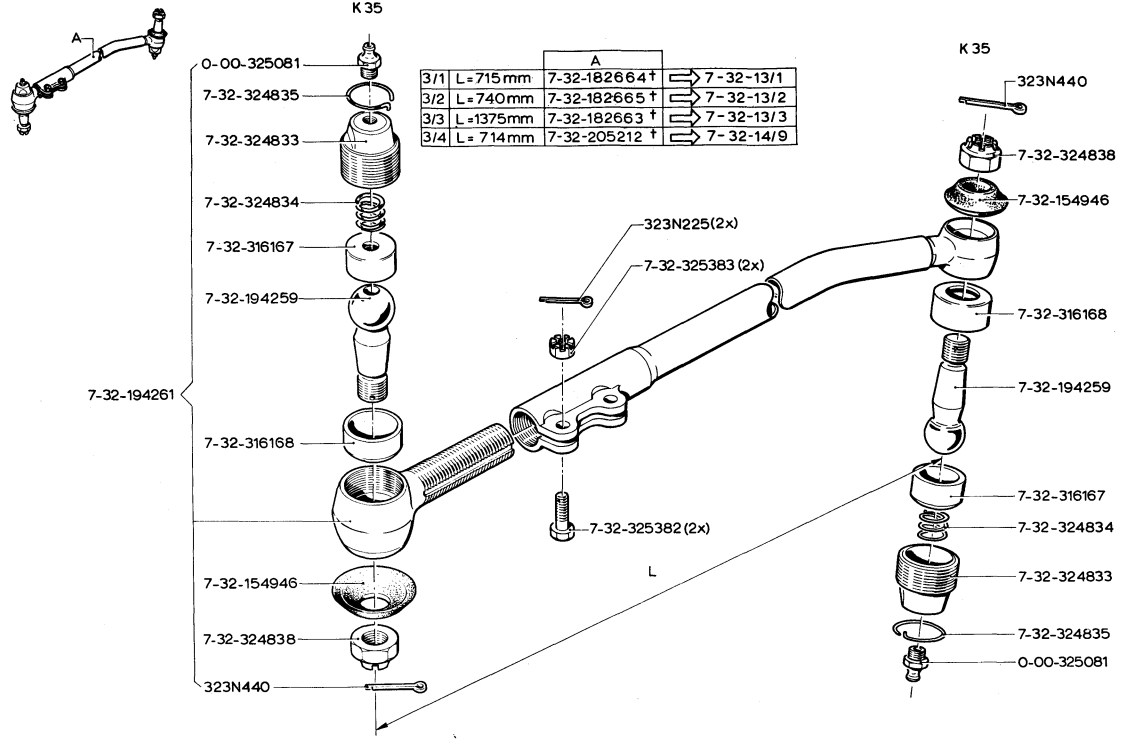

3

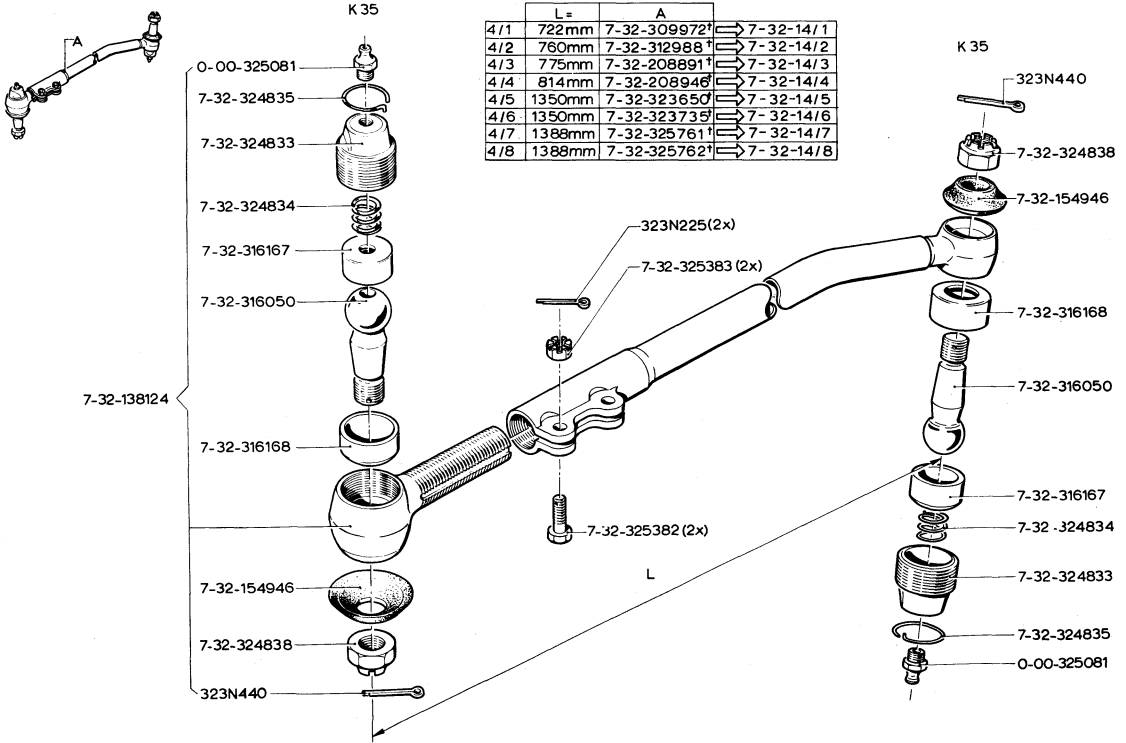

4

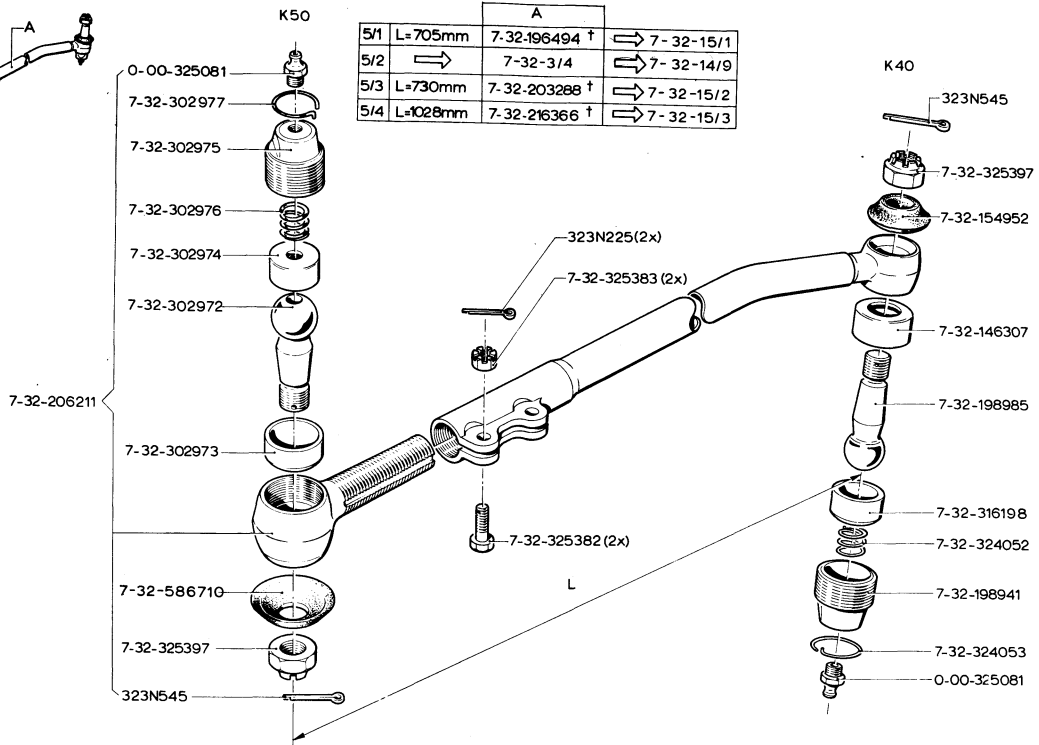
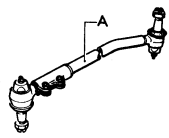

5

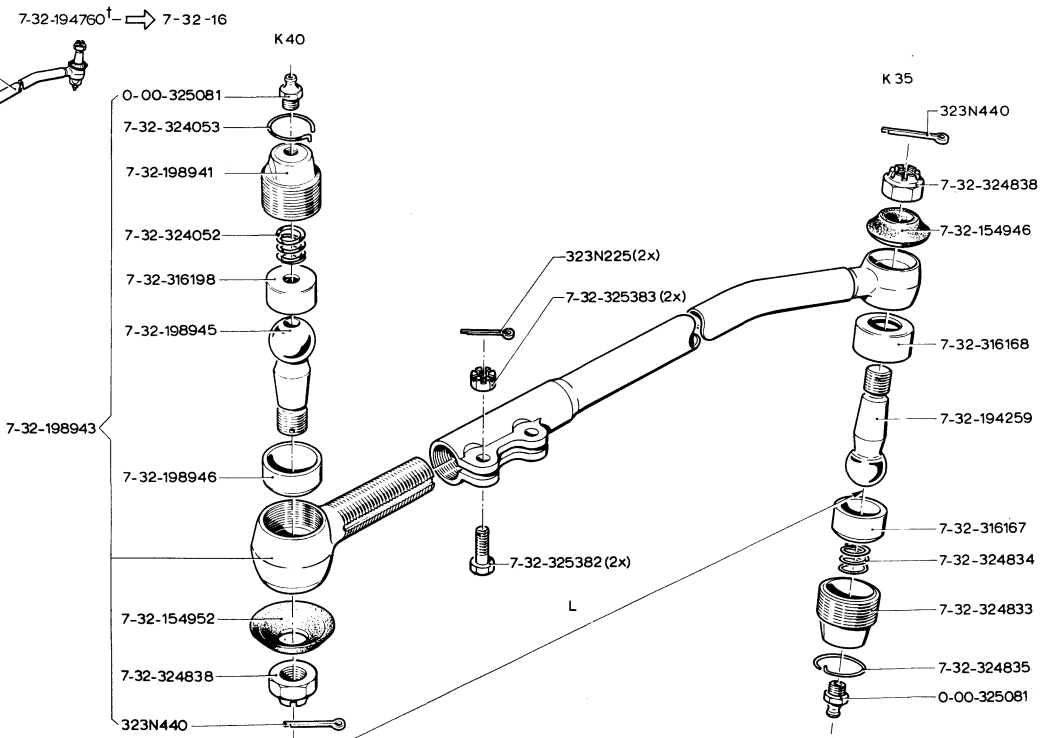
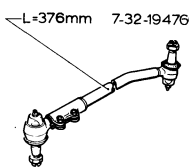

6

Printed in Holland 0 266

	Lmm	A	Lmm	B	
7/1	1010	7-32-305797†	466	7-32-305796†	⇔ 7-32-17
7/2	1035	7-32-206571†	480	7-32-206572†	⇔ 7-32-18

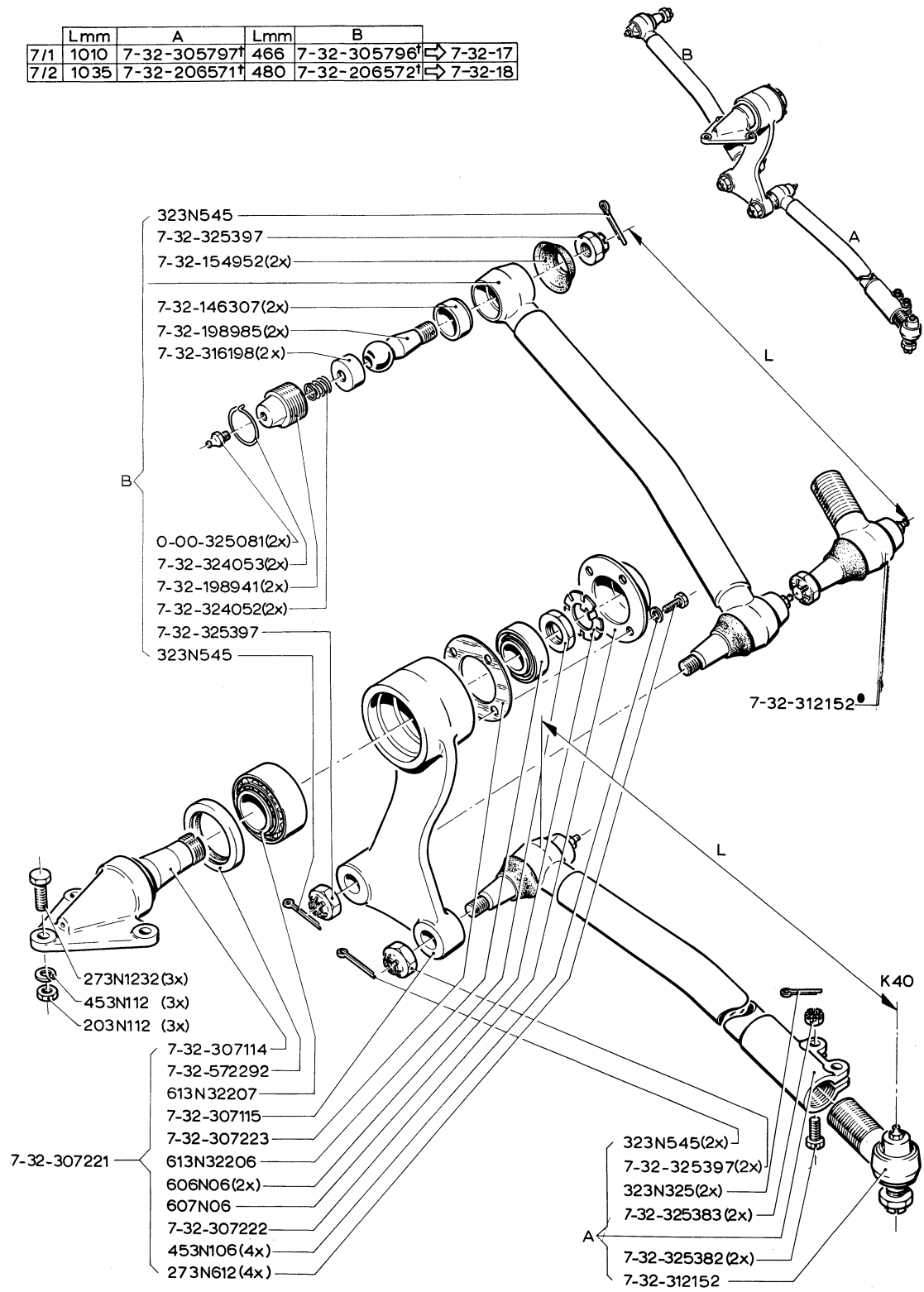

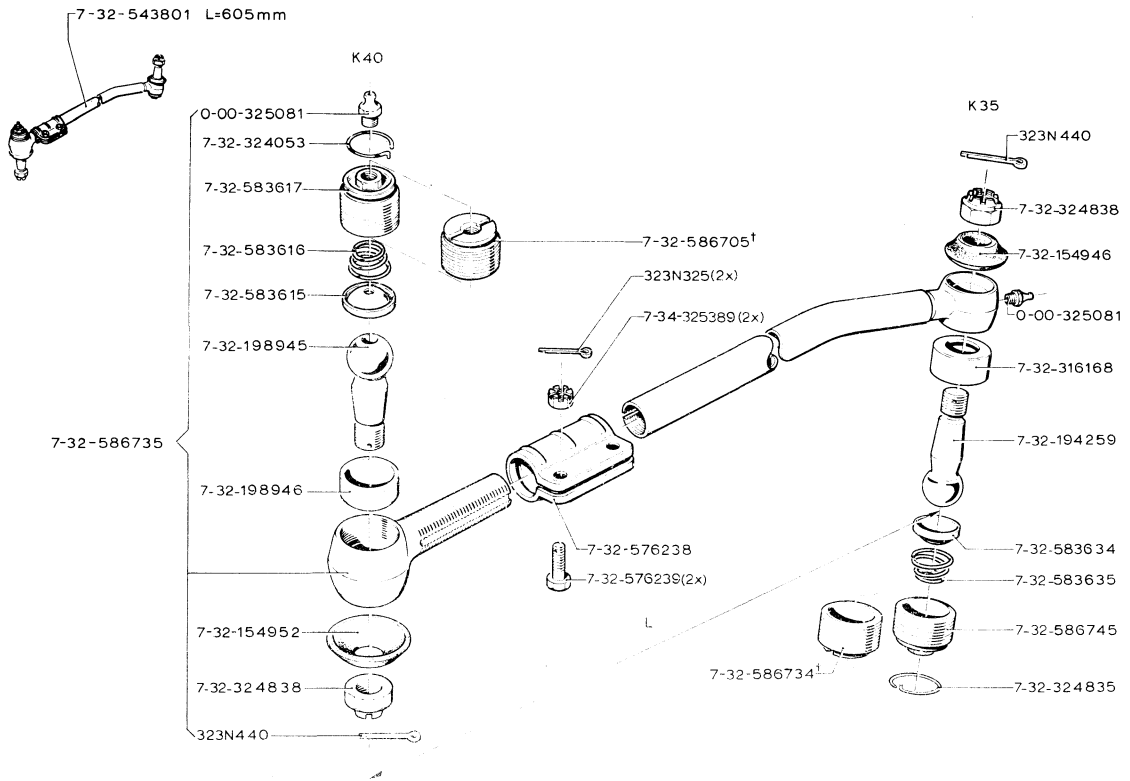

Printed in Holland



7-32-8



0367

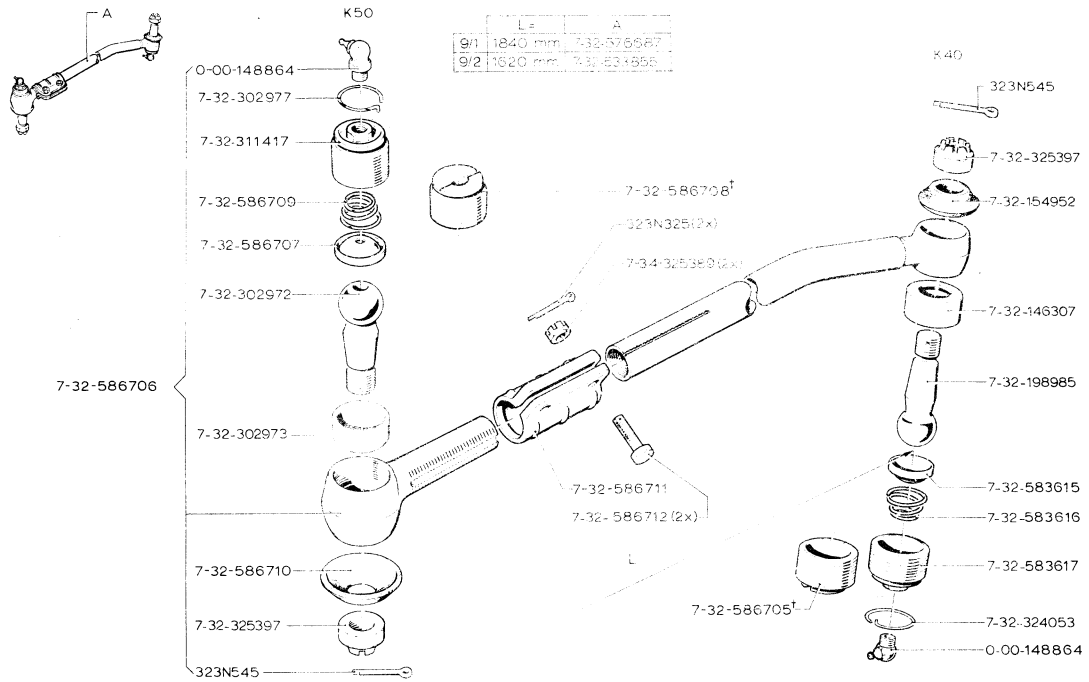

Printed in Holland



7-32-9



0367

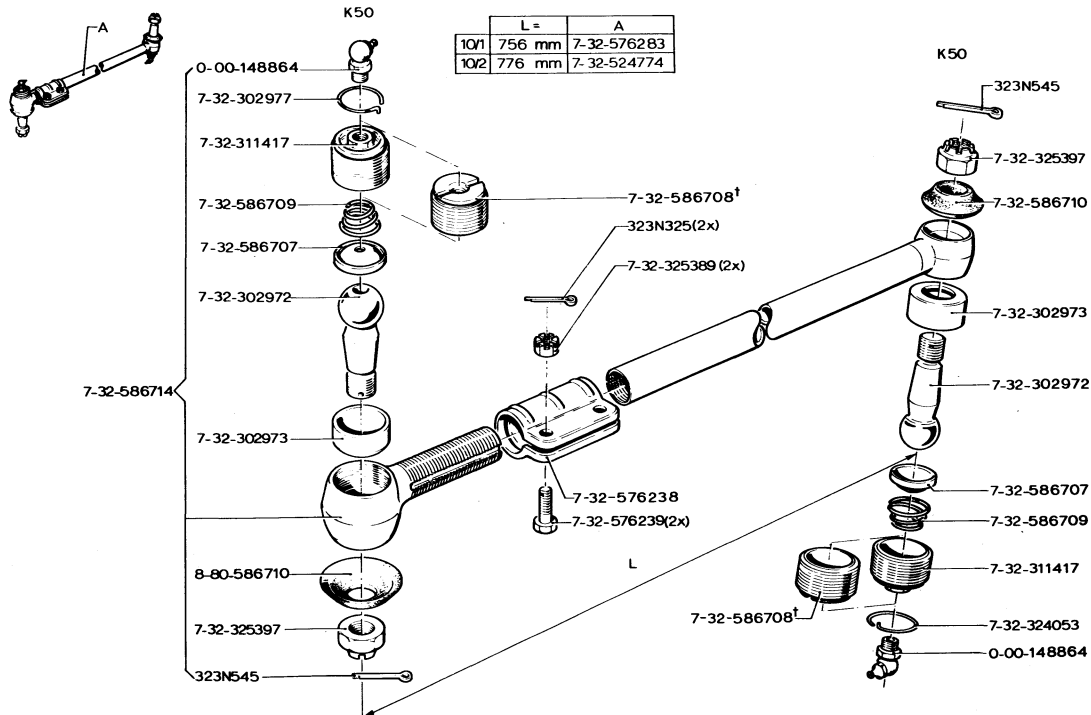

Printed in Holland

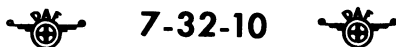

0367

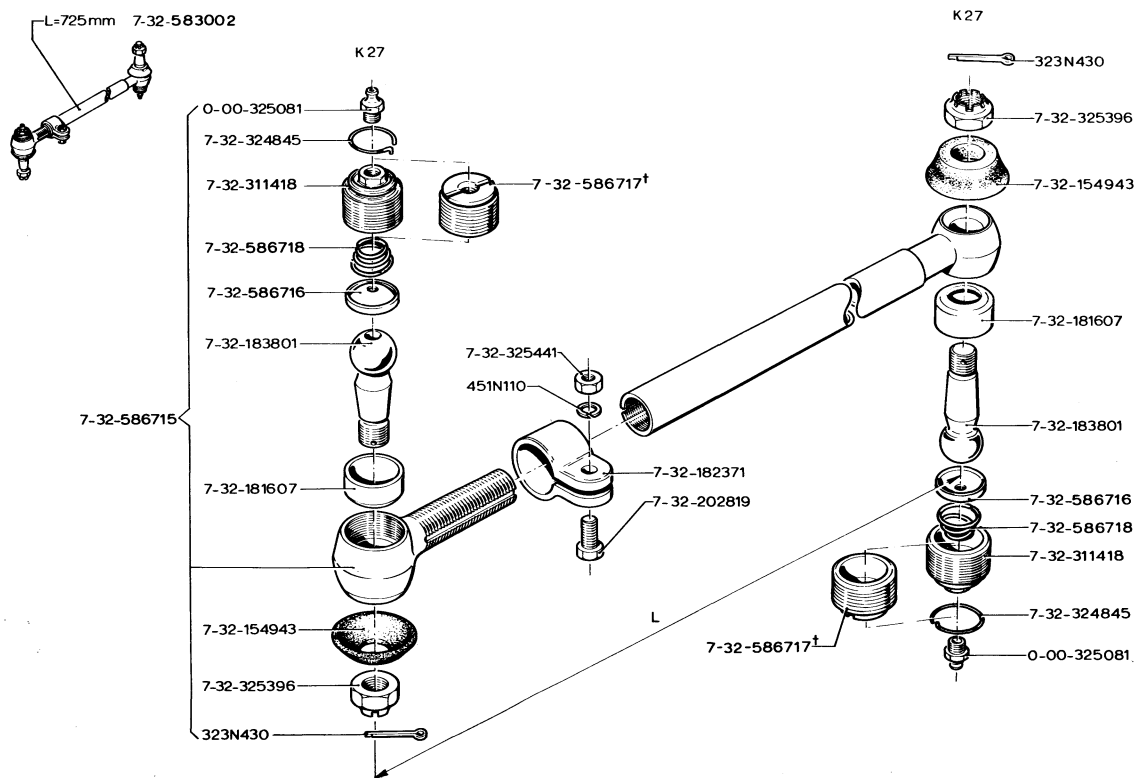

Printed in Holland

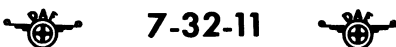

0367

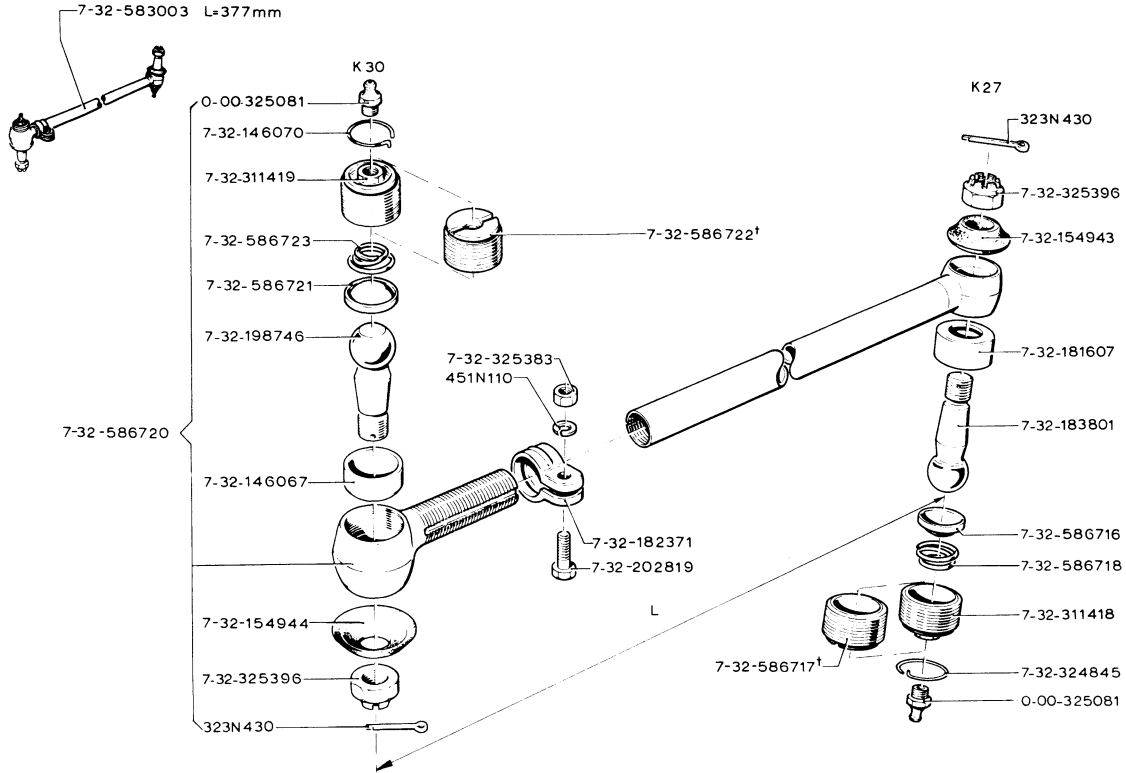

7-32-12

Printed in Holland

1166

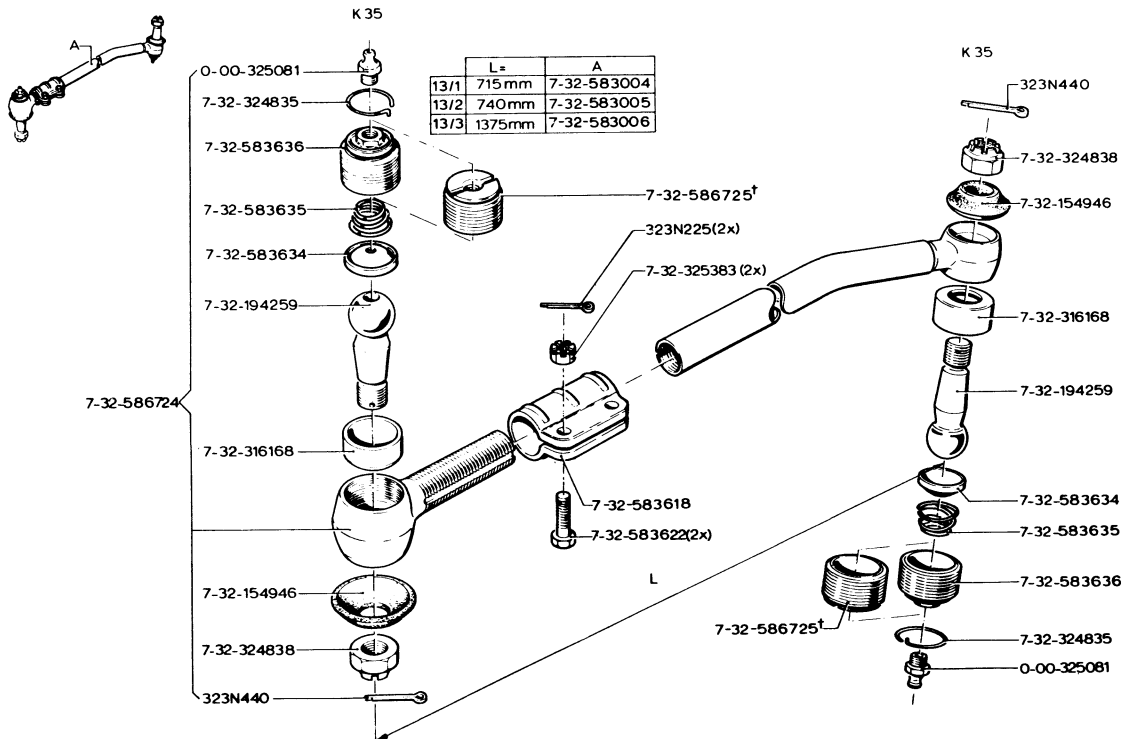

7-32-13

Printed in Holland

1166

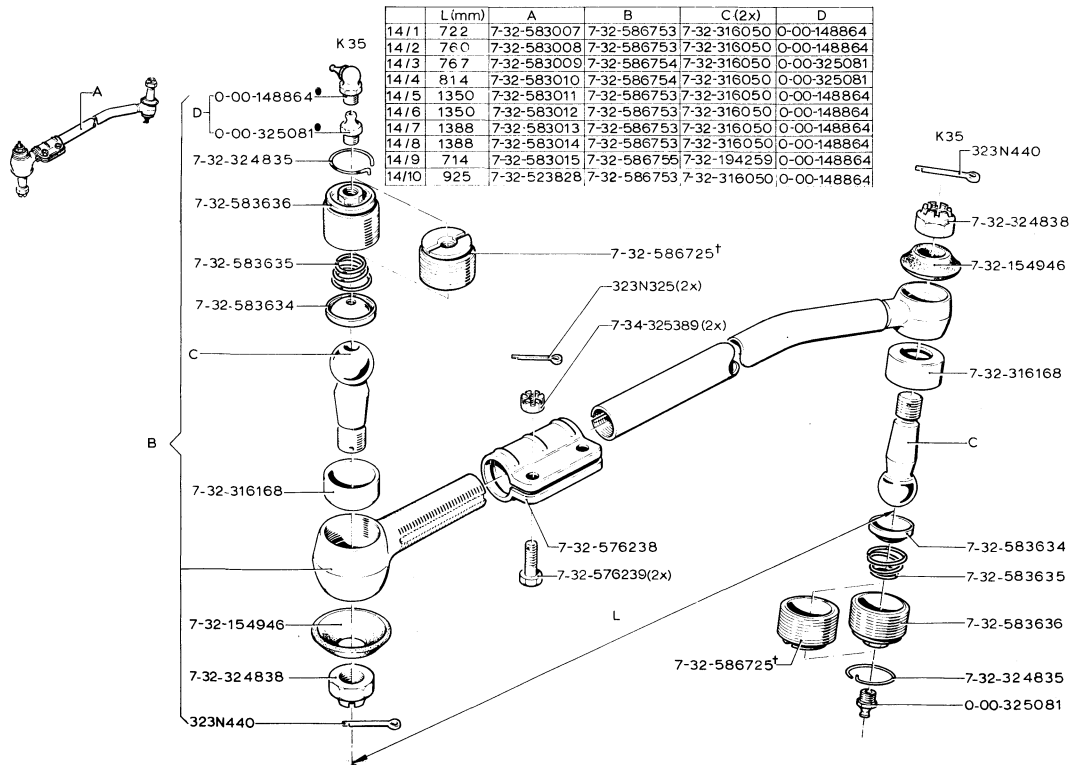

7-32-14

Printed in Holland

1166

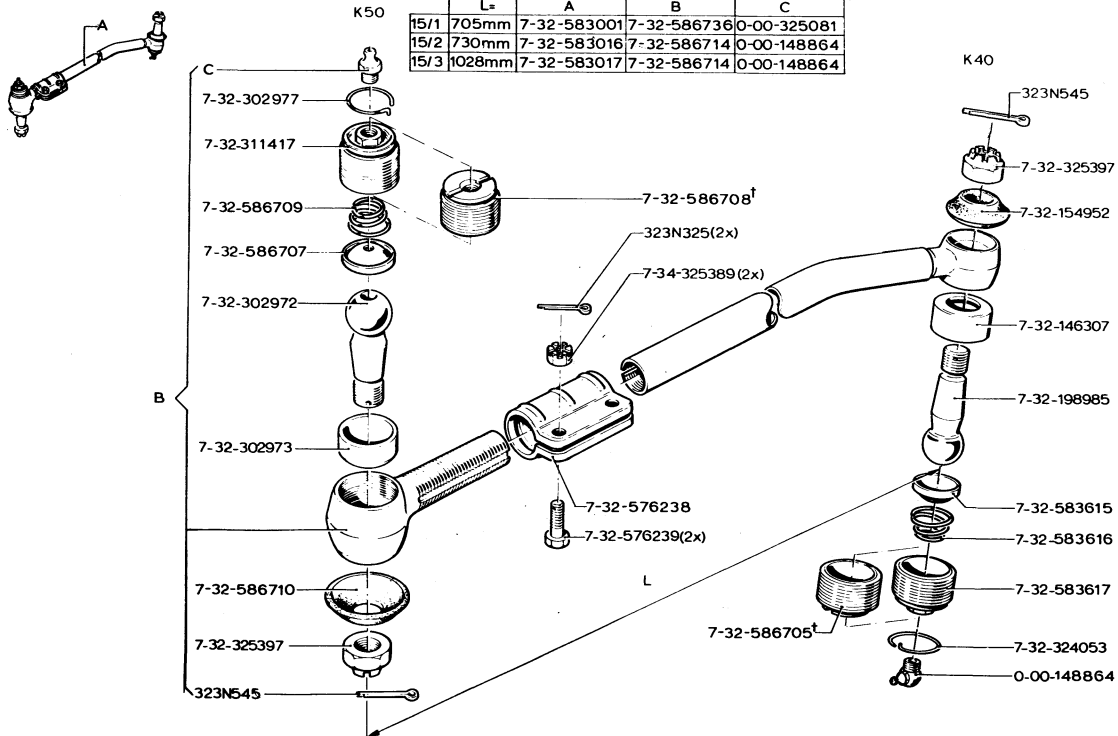

7-32-15

Printed in Holland

1166

STURSTANGEN
DRAG LINKS
BARES DE DIRECCION

LENKSTANGEN
BARRA DE DIRECCION

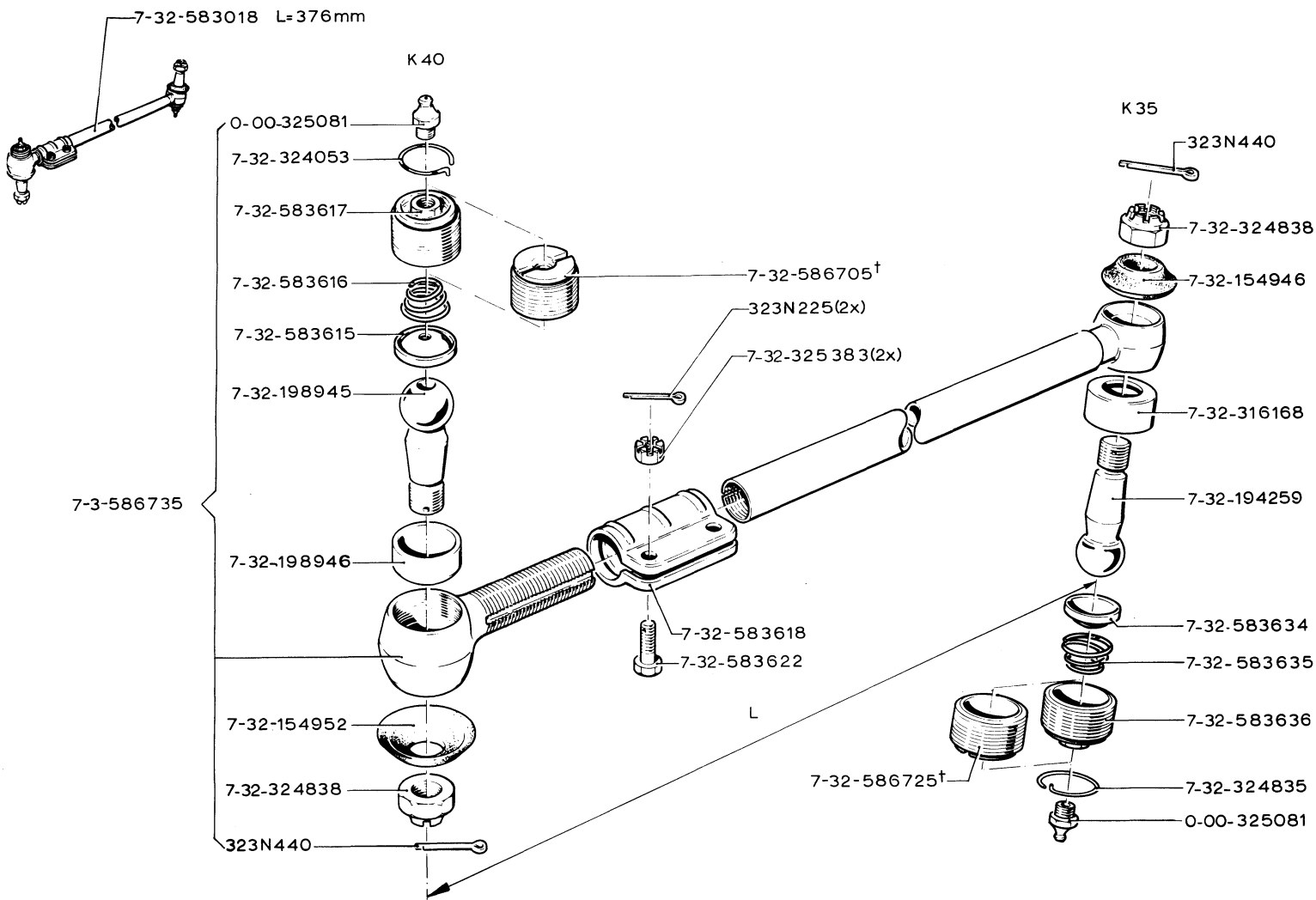

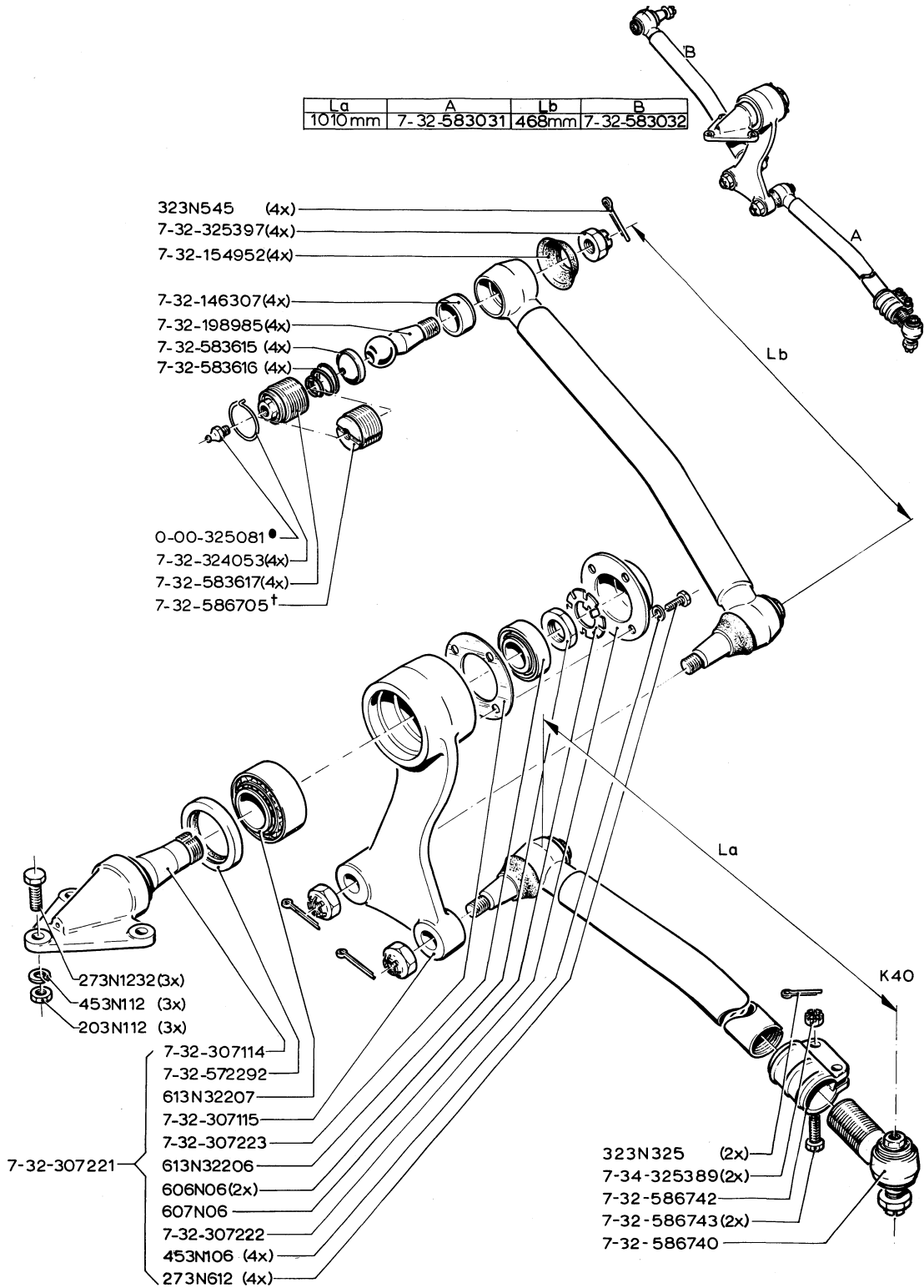

L _a	A	L _b	B
1035mm	7-32-583019	480mm	7-32-583020

