

(P1)

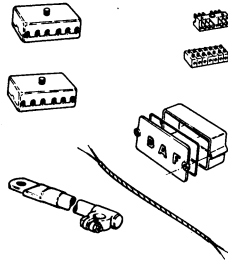

(C1)

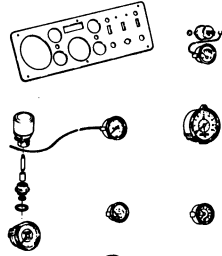

(F1)

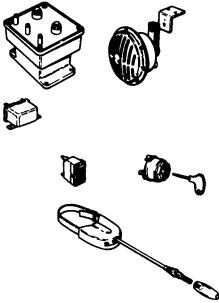

(B1)

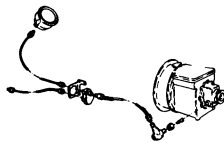

(K1)



⇒ MOTOR SPEC.

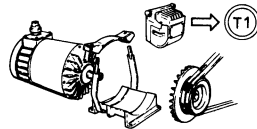
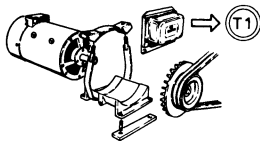

⇒ MOTOR SPEC.

DKDL

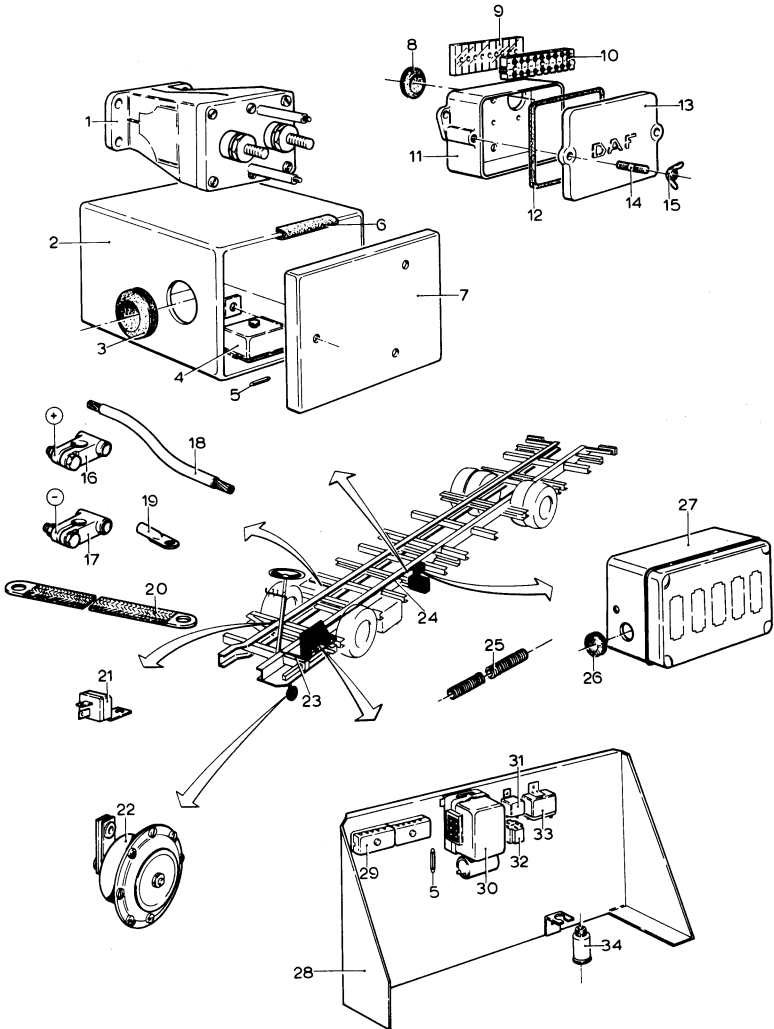

DKTL

