

# SMEERSHEMA

- Multi-purpose vet
- △ Transmissie olie
- ▽ Hypoid olie
- Motor olie
- ◇ Remvloeistof
- S Symmetrisch
- C Controleren
- V Verversen

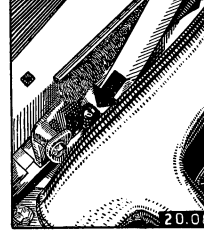
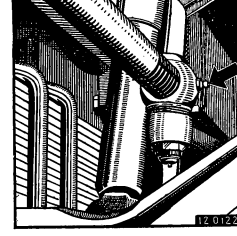
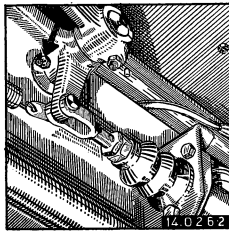
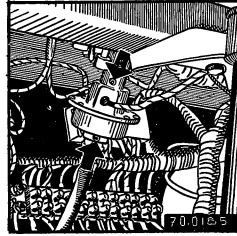
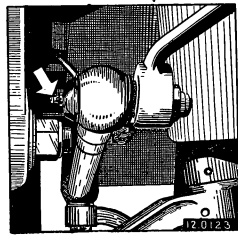
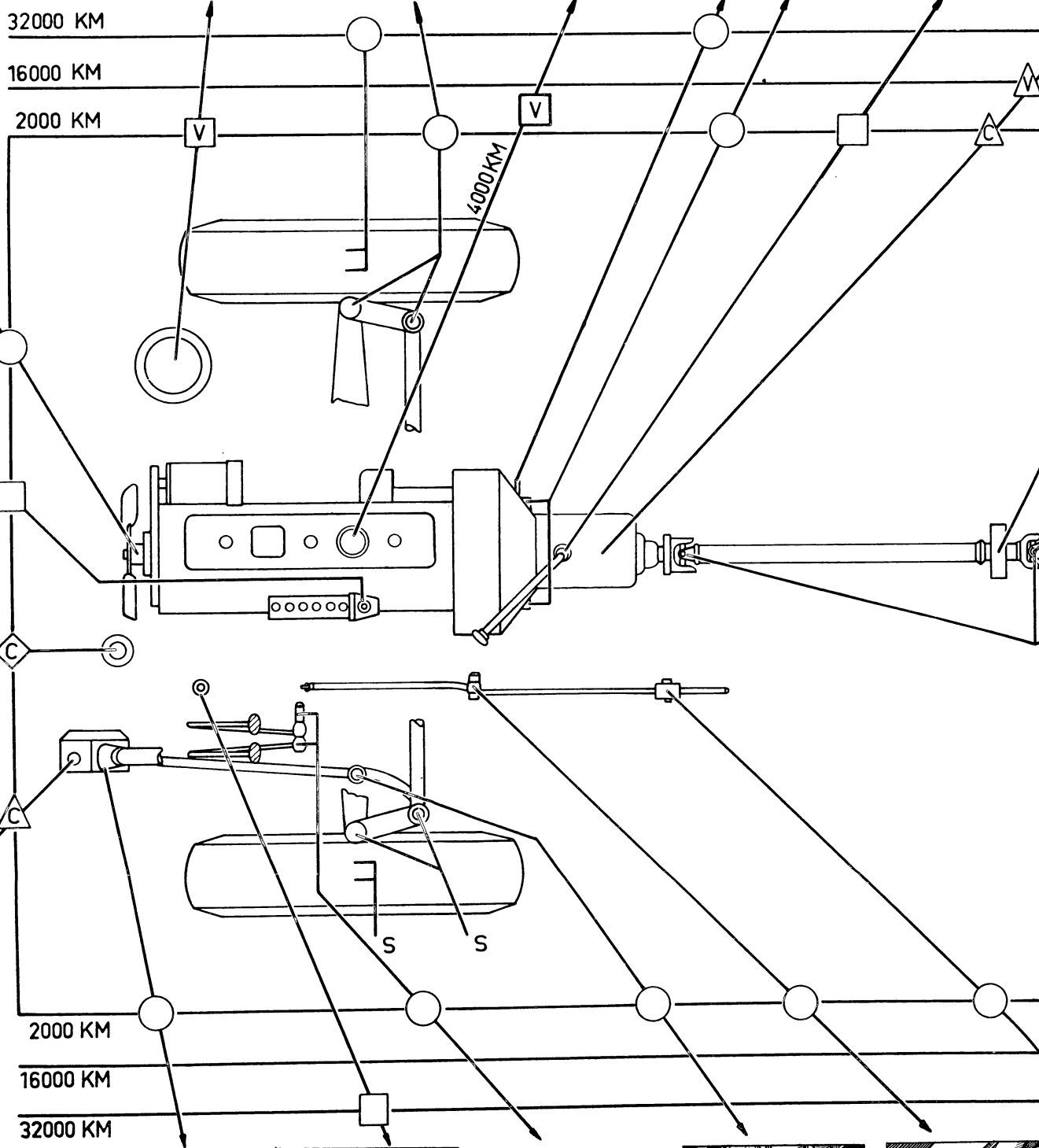
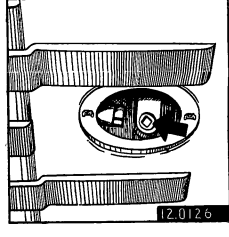
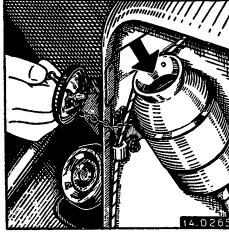
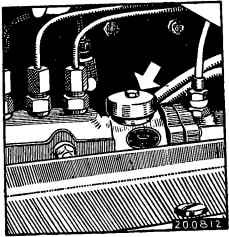
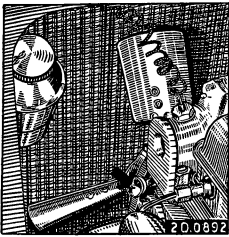
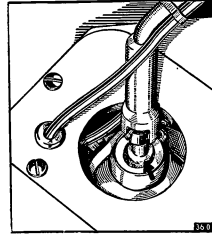
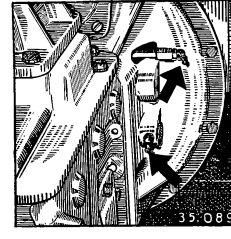
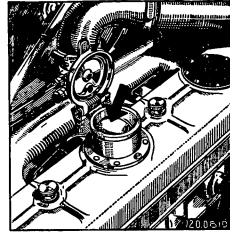
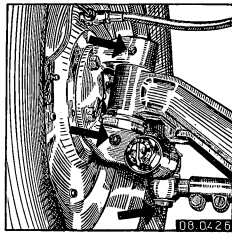
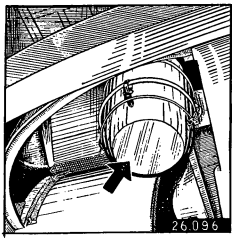

Opn.: 1) Indien een toerenteller gemonteerd is, moet de aandrijving aan de rechterzijde van h  
 2) Smeer koppelschotel van trekker iedere 2000 km.

# SMEERSHEMA

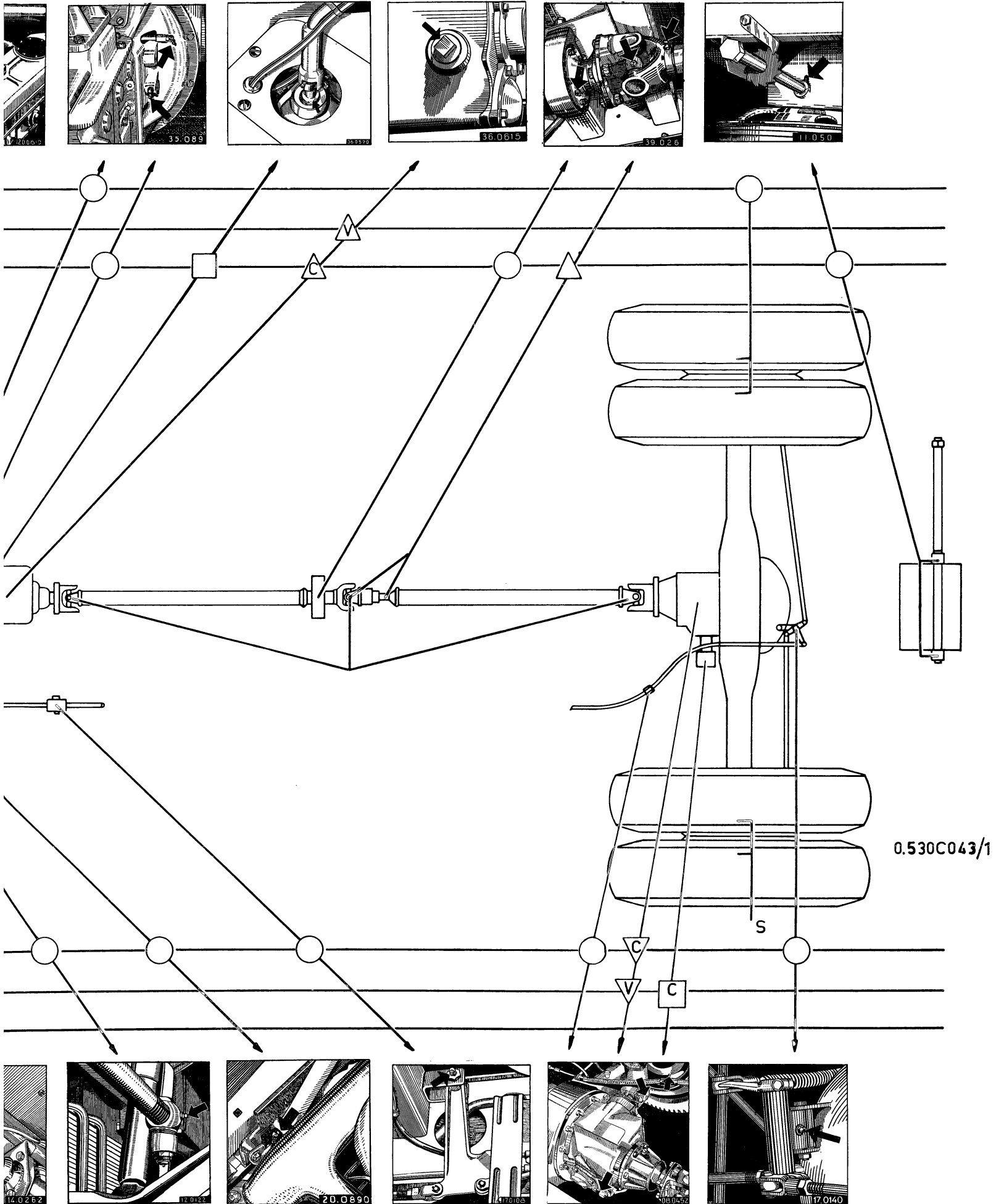

nonteed is, moet de aandrijving aan de rechterzijde van het motorblok iedere 16.000 km spaarzaam met vet gesmeerd worden.  
trekker iedere 2000 km.