

BEDRADINGSSHEMA

1. Richtinglamp
2. Contourlamp
3. Grootlichtlamp
4. Schakelaar luchtfilter
5. Ruitensproeierpomp
6. Alarmschakelaar
7. Sigare aansteker
8. Lichtschakelaar
9. Schakelaar mistachterlamp
10. Voorgloeischakelaar
11. Instrumentenverlichting
12. Startschakelaar
13. Stuurslot, contact-/startschakelaar
14. Combi-schakelaar
15. Brandstofmeter
16. Koelvloeistof temperatuurmeter
17. Luchtdrukmeter
18. Oliedrukmeter
19. Toerental
20. Tachograaf
21. Controlelampen
 - a. Luchtfilter
 - b. Parkeerrem
 - c. Remdruk
 - d. Oliedruk
 - e. Koelwater temperatuur
 - f. Laadstroom
 - g. Richtinglicht
 - h. Grootlicht
22. Schakelaar parkeerrem
23. Richtingautomaat
24. Zoemer
25. Relais stuurslot
27. Relais
- 30.
32. Remlichtschakelaar
33. Vlotter brandstoftank
34. Achteruitrijlamp schakelaar
35. Startmotor
36. Dynamo
37. Oliedruk gever
38. Gever/schakelaar koelvloeistof temperatuur
39. Oliedruk schakelaar
40. Gever toerenteller
41. Relais gloeien
42. Gloeispiralen
43. Hoofdschakelaar
44. Accu's
45. Stekerdoos
achterlampen/achteruitrijlampen
46. Stekerdoos, volgwagen
47. Remlicht
48. zekeringenhouder grootlicht
 - a. 5A Grootlicht, links
 - b. 5A Grootlicht, rechts
 - c. 5A Dimlicht, links
 - d. 5A Dimlicht, rechts
 - e. 5A Zijlichten, links
instrumentenverlichting
 - f. 5A Zijlichten, rechts
 - g. 8A Tachograaf waarschuwingssknipper-
lichtschakelaar
- h. 8A Schakelaar achteruitrijlamp
- j. 8A Schakelaar achtermistlamp
- k. 5A Ruitewisserinstallatie
- l. 8A Sigare-aansteker
- m. 5A Tachograaf/schakelaar remlichten

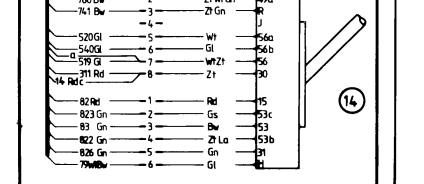
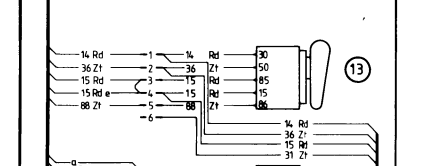
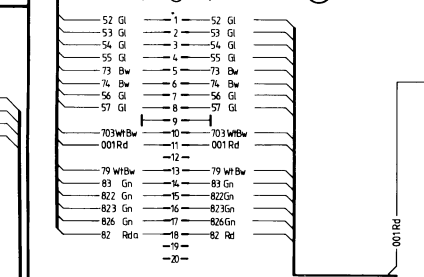
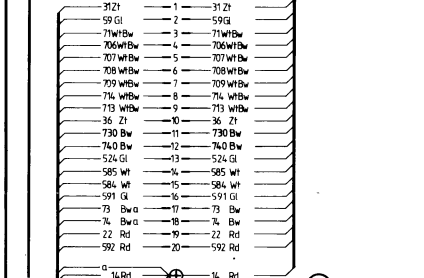
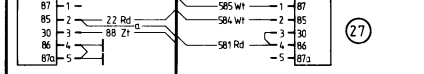
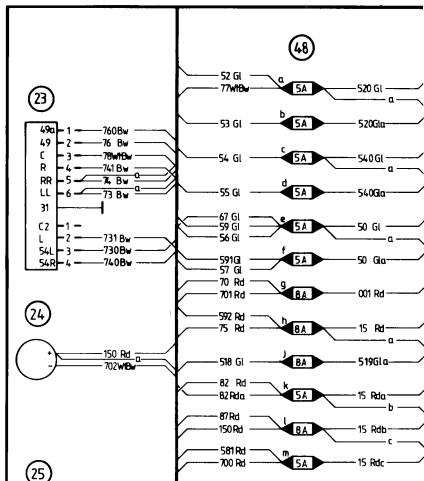
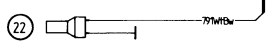
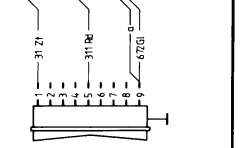
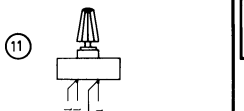
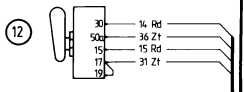
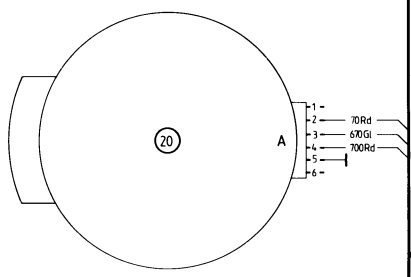
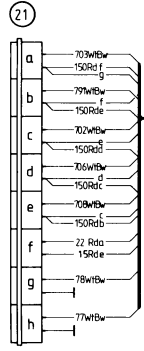
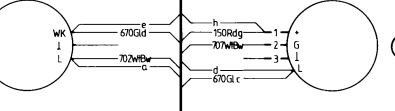
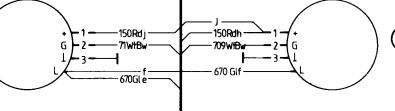
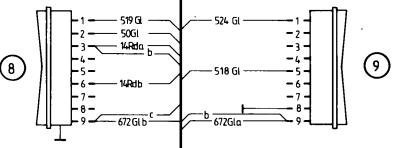
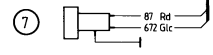
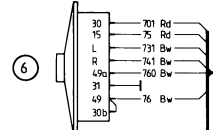
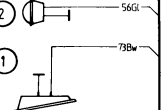
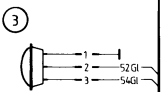
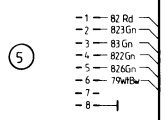
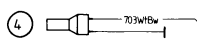
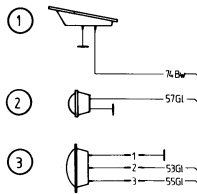

48

23

24

25

27

19

30

12

11

10

14

001 Rd

